

RST Brands Collection

Barcelo Dining Chair

Model: OP-PETS6-BAR-Chairs

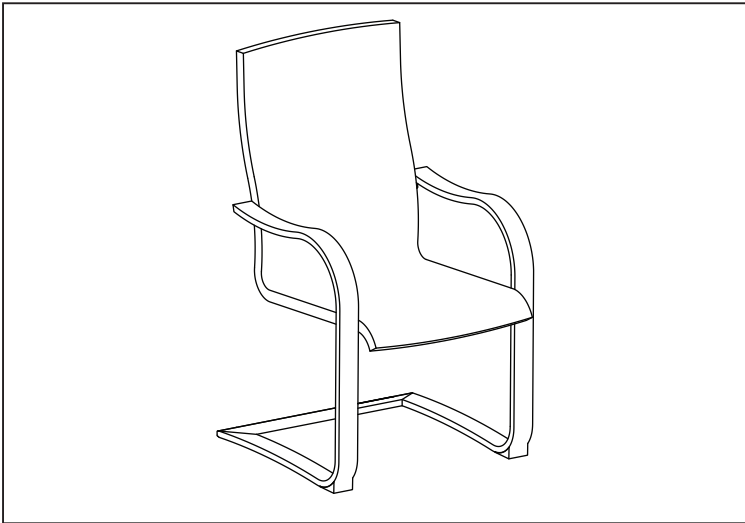

Assembly Instructions







**IMPORTANT, RETAIN FOR FUTURE REFERENCE.
READ CAREFULLY.**

For assistance with assembly or customer service,
call 1-877-924-2090 (English) Monday - Friday, 8 a.m. to 5 p.m. Mountain Time, North America.
Email: customerservice@rstbrands.com or visit our website at www.rstbrands.com.

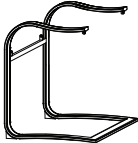
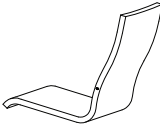

Quality & Value. Always in Style.

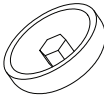
Parts List

NO.	PICTURE	PART DESCRIPTION	QTY
A		Leg Frame	1
B		Seat	1
C		Bolt (M6 x 25)	2
D		Bolt (M6 x 45)	2
E		Washer	4
F		Plastic Bolt Cap	4
G		Allen Wrench	1

Step 1.

SEAT ASSEMBLY - Attach the leg frame (A) to the seat (B) using the allen wrench (G) to secure the bolts and washers (C+E) at the chair back, and (D+E) at the chair base. Secure with the plastic bolt caps (F).

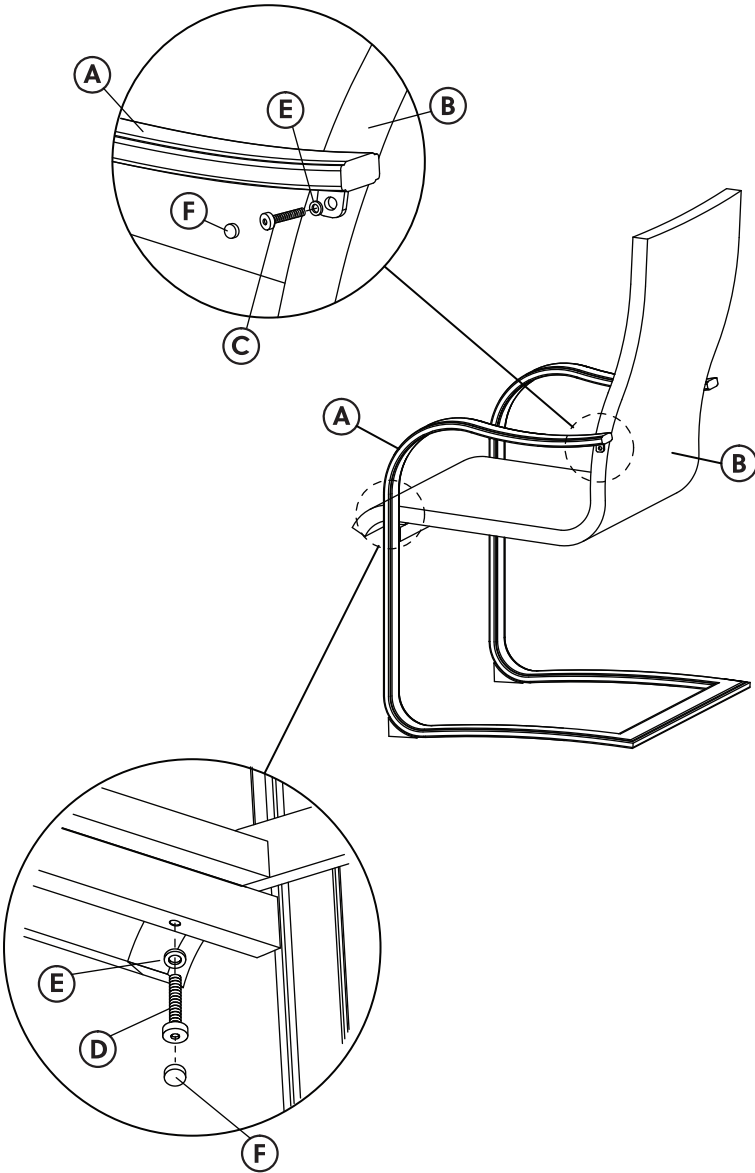

Care & Maintenance

All outdoor furniture is subject to UV rays and weather elements. In order to keep your furniture as long lasting and vibrant as possible, simply rinse and use a mild soap to clean the frame. We advise using furniture covers or storing the furniture when not in use. Refer to the stain chart for fabric care.

RST Brands Collection

Table de salle à manger Barcelo

Modèle: OP-PETS6-BAR-Chairs

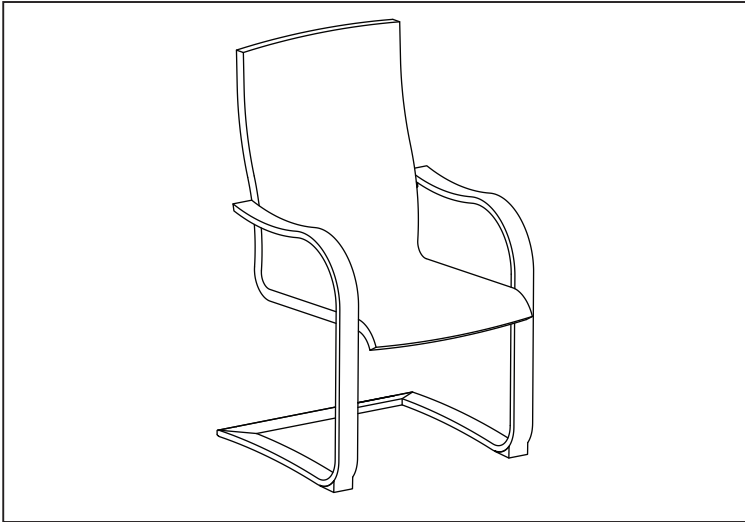

Instruction D'assemblage







**IMPORTANT, À CONSERVER À TITRE DE RÉFÉRENCE.
À LIRE ATTENTIVEMENT.**

Pour de l'aide à l'assemblage ou le service à la clientèle, composez le 1-877-924-2090 (Anglais)
Lundi - vendredi 8 heures-17 heures, heure des Rocheuses, en Amérique du Nord.
Email: customerservice@rstbrands.com ou visitez notre site Web à rstbrands.com.

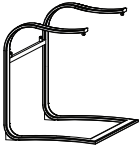
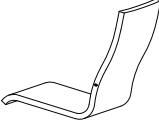

Quality & Value. Always in Style.

Liste Des Pièces

NO.	IMAGE	RÉFÉRENCE DESCRIPTION	QTÉ
A		Cadre des pieds	1
B		Siège	1
C		Boulon (M6 x 25)	2
D		Boulon (M6 x 45)	2
E		Rondelle	4
F		Boulon en plastique	4
G		Clé Allen	1

Étape 1.

ASSEMBLAGE DU SIÈGE - Fixer le cadre (B) des pieds au siège (B) en utilisant la clé Allen (G) pour serrer les boulons et rondelles (C+E) au dossier de la chaise, et (D+E) à la base de la chaise. Les sécuriser avec les cache-boulons (F) en plastique.

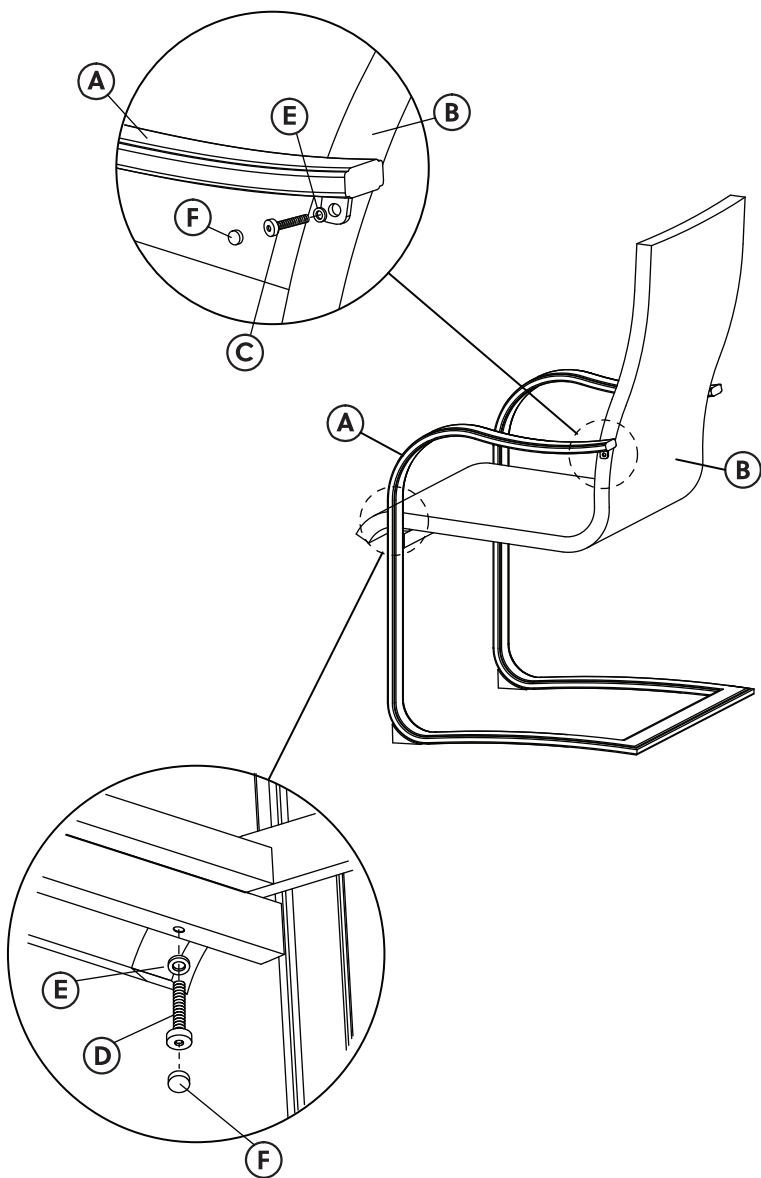

Entretien Et Maintenance

Tous les meubles d'extérieur sont soumis aux rayons UV et aux intempéries. Afin que vos meubles durent aussi longtemps que possible et que leur couleur reste vibrante, simplement rincer et nettoyer le cadre avec un savon doux. Lorsqu'ils ne sont pas en cours d'utilisation, Il est conseillé de recouvrir les meubles de housses ou de les entreposer. Consulter les directives d'entretien des tissus figurant dans le diagramme des taches.

RST Brands Collection

Silla de comedor Barcelo

Modelo: OP-PETS6-BAR-Chairs

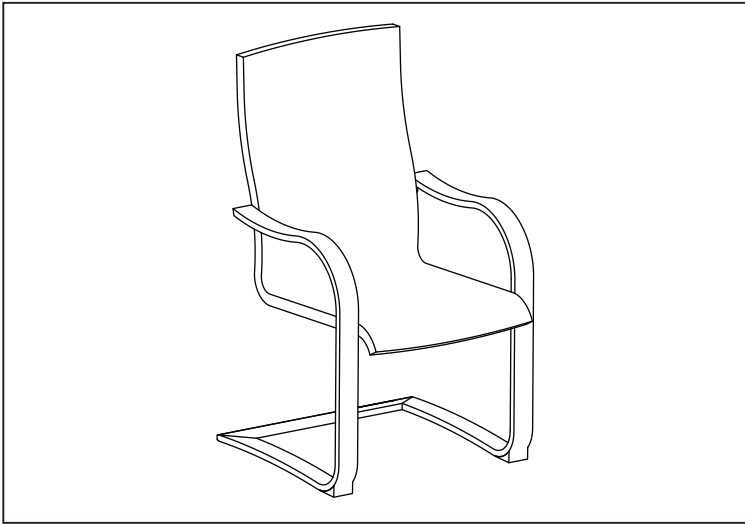

Manual de Instrucciones y Ensamble







**IMPORTANTE, RETENER PARA FUTURAS CONSULTAS.
LEA CUIDADOSAMENTE.**

Para asistencia con el ensamblaje e instalación de las partes y servicio al cliente llame:
1-877-924-2090 (Inglés) Lunes - Viernes 8 a.m. - 5 p.m. Hora de la Montaña, Norte América.
Póngase en contacto con nosotros por correo electrónico a customerservice@rstbrands.com o
visite nuestro sitio web en www.rstbrands.com.

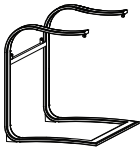

Quality & Value. Always in Style.

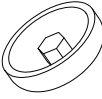
Parts List

NO.	IMAGE	DESCRIPTCIÓN (PARTE)	CANT.
A		Base de las patas	1
B		Asiento	1
C		Tornillos (M6 X 35)	2
D		Tornillos (M6 X 45)	2
E		Arandela	4
F		Tapa del tornillo de plástico	4
G		Llave Allen	1

Paso 1.

ENSAMBLAJE DE LA SILLA - Fije la base de las patas (A) al asiento (B) utilizando la llave Allen (G) para fijar los tornillos y arandelas (C + E) al respaldo (D + E) y la base de la silla. Asegure con las tapas de los tornillos de plástico (F).

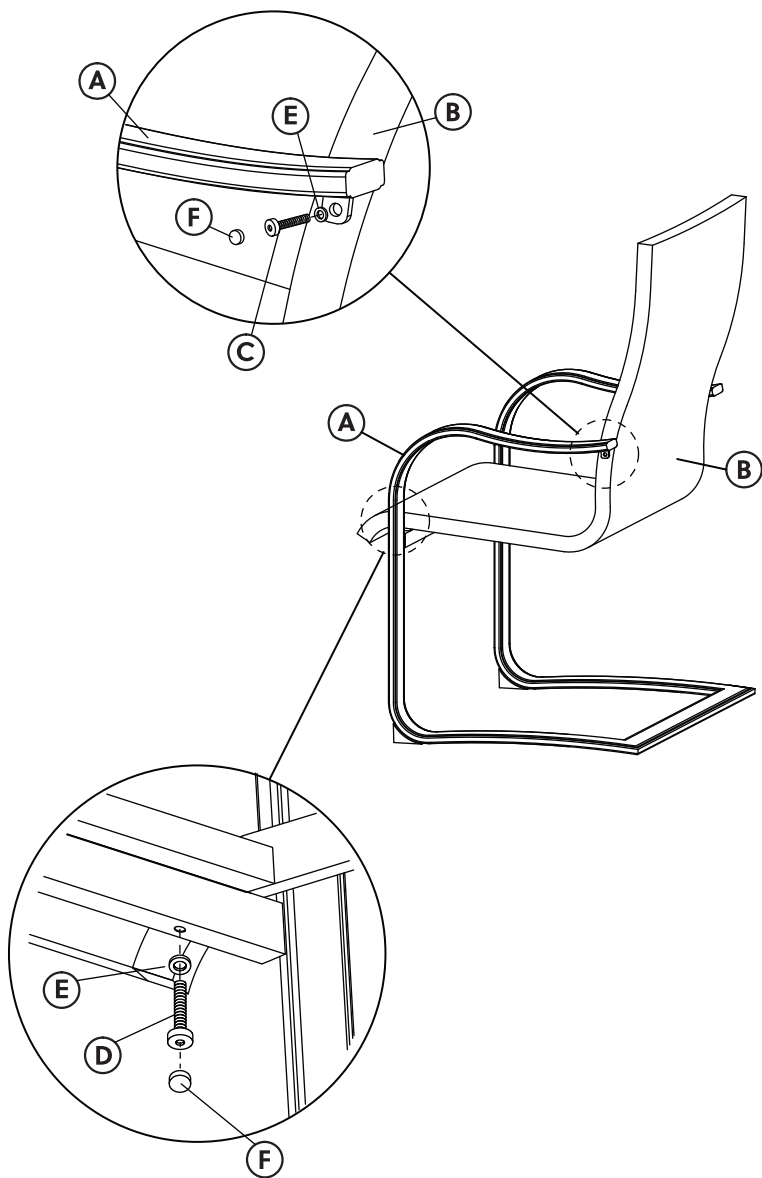

Cuidados Generales

Todo los muebles al aire libre está sujeta a los rayos UV y las inclemencias meteorológicas. Con el fin de mantener sus muebles y los más vibrante posible, simplemente enjuagar y usar un jabón suave para limpiar el marco. Se aconseja el uso de abrigo de muebles o el almacenamiento de los muebles cuando no esté en uso. Consulte la tabla de la mancha para el cuidado de tejidos.